



# il series

material origin: U.S.A. 

price index: \$ - \$\$\$



# id series

material origin: U.S.A. 

price index: \$ - \$\$\$



-  660 ultra touch white
-  650 white matte
-  700 smooth
-  145 satin white
-  129 soft snow white
-  245 diva
-  610 winter grey matte
-  611 mountain grey matte
-  630 sienna matte
-  615 graphite grey matte
-  239 mystique
-  297 real wenge

**Pick your door profile**



Tacoma (TA)



Frontier (FT)



Windsor (WN)



Outback (OB)

\* please check online or visit our showroom for more options of door profile and color.



**Pick your door profile**



DR112



RR980 with OE480



STELLA370



RR980



DR112  
with 1/8"routed from face



DRS131

\* please check online or visit our showroom for more options of door profile and color.

-  949w white
-  satin white
-  snow white
-  white portuna
-  turmalin matte
-  umbra matte
-  gauntlet grey
-  sienna matte
-  dark italian walnut
-  cocoa cherry
-  chocolate pear
-  deep grain wenge

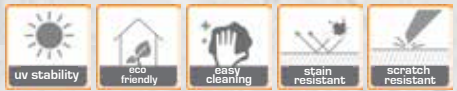

The ID & IL series are dent resistant and easy to clean with a simple soap and water solution. Made of approximately 90% wood fibers and 10% resin to hold it together, MDF maximizes the use of our forest resources by utilizing the residual wood element of forests not used in producing lumber, which could have otherwise ended up in landfills.



# floating shelf



- accommodate perfect for today's transitional or contemporary kitchen and bathroom styling
- use functionally to store plates, glasses or decorative items in the kitchen
- unique hanging system safely supports 10 pounds per running foot of shelf length, metal bracket included
- miter fold construction on an engineered custom core
- width available in 3" increments from 24" to 72"
  - standard grain orientation: horizontal top/bottom/all edges
  - vertical top/bottom/front edge CANNOT be produced

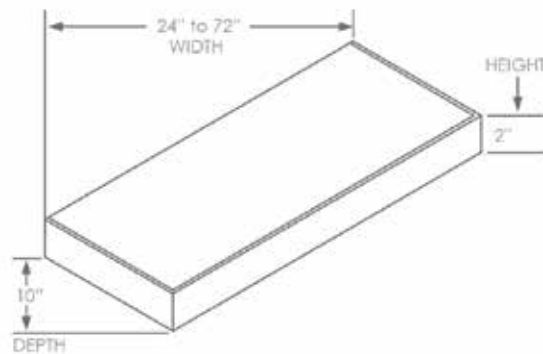
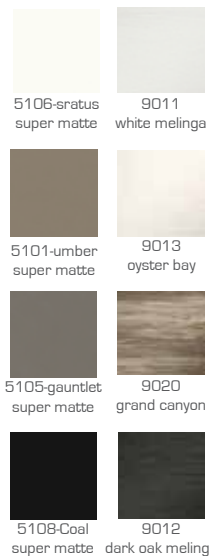

\*please check out our website or visit our showroom for more color options.



# impressions collection | 2 series

The Impressions collection features thermofoil doors which are made using a flexible vinyl material that is applied by heating the vinyl and molding it over medium-density fiberboard (MDF). It has a flawless, silky-smooth surface that resists chipping better than painted surfaces.

If you are searching for reasonably-priced kitchen cabinets with little maintenance required, do not hesitate to select thermofoil kitchen cabinets.

Advantages of thermofoil cabinets:

- easy care and low maintenance
  - the laminate surface resists stains and is easily wiped down. Stubborn residues such as grease can be removed with a mild all-purpose cleaner. Thermofoil doesn't require protective coatings, as wooden cabinets do, which means they need less maintenance.
- uniform look from door to door,
  - this kind of cabinet door is the best substitute for solid wood.
- design and color versatility
  - a major advantage of thermofoil cabinets is their wide range of color and pattern options. The vinyl surface of these cabinets may be molded into a variety of patterns and shapes, which allows you the choice of a basic flat cabinet, or one with an embellished design; you also have the option of matte or glossy finishes.

The Impressions collection includes two series:

- il
- id

\* Wood grain representations may vary from the product image. Please see actual sample for more accurate color and comparison.

